



**AIR INSULATED
EXTENDABLE
SWITCHGEAR MSG^{AIR}
UP TO 17.5KV GUIDE**



Certificate Number FM35831

APPLICATION

Typical Uses and Classification

The MSGair switchgear is used in transformer and switching substations mainly at the primary and secondary distribution level eg:

Applications

UTILITIES AND POWER PLANTS

- Power generation stations
- Transformer stations
- Switching stations
- Main and auxiliary switchgear

INDUSTRY

- Automotive
- Textile, paper and food industry
- Petrochemical

TRANSPORT

- Airports
- Port installations
- Railways
- Underground railways

SERVICE SECTOR

- Supermarkets
- Shopping malls
- Hospitals
- Large infrastructures



The MSGair is a factory assembled, single busbar, type tested, medium voltage, metal enclosed, air-insulated switchgear suitable for indoor installations.

The MSGair switchgear and its components have been designed and tested to IEC 62271 standards ensuring maximum operational reliability and safety.

Metallic partitions segregate the switchgear's main compartments.

APPLICATION

Typical Uses and Classification

The switch gear's design is modular with units easily installed side by side enabling the possibility of future extensions. In this way the MSGair switchgear is suitable both as wall mounted and as a free-standing arrangement in electrical service locations up to the maximum short-circuit rating.



LOSS OF SERVICE CONTINUITY CATEGORY AND PARTITION CLASS

Loss of service continuity category	LSC 2B
Partition class	PM

ACCESSIBILITY OF COMPARTMENTS

Busbar compartments	Tool-based
Switching device compartment	Interlock-controlled
Feeder compartment	Tool-based or Interlock-controlled

INTERNAL ARC CLASSIFICATION

The following internal arc classifications are fulfilled: IAC A FLR I_{sc} t

IAC	= Internal arc classification
A	= 300mm distance of indicators for test (installation in closed electrical service position)
F	Front arrangement for indicators
L	Lateral arrangement for indicators
R	Rear arrangement for indicators
Isc	Test current of up to 31.5kA
t	1s

CUSTOMER BENEFIT

Security of operation, peace of mind and cost effective



- When having air as an insulating medium no handling of insulating gas or gas pressure monitoring is required.
- As insulating medium, air is always available.
- Use of maintenance-free withdrawable vacuum circuit breakers.
- Optional withdrawable Sulphur hexafluoride (SF6) withdrawable circuit breaker.
- Type tested circuit breaker.
- Type tested make-proof earthing switch.
- Pressure-resistant partitions.
- All operations are at operator interface level.
- Personnel safety is ensured as all operations are performed with door compartments closed.
- Safe switching operations even with loss of auxiliary, all CB operations can be done with doors closed either electrically or manually.
- All external opening on CB door are blocked to maintain maximum operator safety under IAF conditions while allowing for manual operation in case of auxiliary supply fail.
- Metallic enclosure, earthed shutters and partitions.
- Voltage presence indicators on instrument panel door.
- Standard degree of protection IP4X.
- Positively driven shutters with independent locking systems.
- Logical electro-mechanical system.
- Logical mechanical interlocking system.
- Use of standardized block-type current and voltage transformers.
- Optional withdrawable voltage transformer.

**MAINTENANCE-
FREE**

SAFE

LOGICAL

RELIABLE

TECHNICAL DATA

Electrical data, Standards and Degree of protection

ELECTRICAL CHARACTERISTICS OF THE SWITCHGEAR

Rated Voltage	kV	17.5
Test voltage at power frequency	kV for 1 min	38
Rated Impulse Withstand Voltage	kV	95
Rated frequency	Hz	50
Rated short time-withstand current	kA for 3s	31.5
Peak Withstand current	kA	80
Rated current of main busbars	A	2000
Rated current of feeder connections	A	2000

ENVIRONMENTAL CONDITIONS

The switchgear ratings are guaranteed under the following environmental conditions.

Minimum ambient temperature	-5°C
Maximum ambient temperature	up to +50°C
Maximum relative humidity	95%
Maximum altitude	1000m.
In presence of unpolluted and non-corrosive atmosphere	

ELECTRICAL CHARACTERISTICS OF THE EARTH SWITCH

Rated voltage	kV	17.5
Short time withstand current/ Short-time making capacity	kA	31.5 x 3s
Peak current	kA	80
Endurance class	E2	

STANDARDS

MSGair switchgear complies with the relevant standards and specifications applicable at the time of the type tests.

- IEC 62271-200 for the switchgear
- IEC 62271-100 for the circuit-breaker
- IEC 62271-102 for the earthing switch
- IEC 61869-2 for voltage transformers
- IEC 61869-1 for current transformers
- IEC 60529 for the degree of protection
- IEC 62271-206 for the voltage presence indication system

DEGREE OF PROTECTION

The degree of protection of the switchgear comply with IEC 62271 standards.

Degree of protection of:

- External housing - IP4X
- Between Partitions - IP2X

DESIGN

Switchgear compartments

The MSGair is segregated into three power compartments: the busbar compartment; the circuit breaker compartment and the feeder compartment. The MSGair also has three other auxiliary compartments: the instrument compartment; the auxiliary circuit wiring duct and the voltage transformer compartment.

BUSBAR COMPARTMENT

The busbar compartment houses the main busbar system. Branch connections connect the busbar to the circuit breaker fixed isolating contacts.

The main busbars are made from electrolytic copper.

CIRCUIT BREAKER COMPARTMENT

The circuit breaker compartment houses metallic type shutters which are positively driven by the withdrawable circuit breaker. These shutters can be locked independently. The shutters can be fitted with an optional fail-safe device which prevents the shutters from being manually opened when the circuit breaker is removed and the door is open.

CABLE COMPARTMENT

The feeder compartment houses the branch connection system to connect the power cables to the fixed isolating contacts of the circuit breaker.

These branch connections are also made from electrolytic copper.

INSTRUMENT COMPARTMENT

The instrument compartment houses necessary wiring controls of the switchgear unit. The standard height is suitable for 1 tier of relays. An overcurrent time and earth fault protection relay is installed on feeder and bus tie units. Circuit breaker control commands are also available on the instrument compartment. A voltage presence indicator is also installed in the instrument compartment.

AUXILIARY CIRCUIT WIRING DUCT

A metallic auxiliary wiring duct is available on each instrument panel in order to facilitate auxiliary panel wiring.

VOLTAGE TRANSFORMER COMPARTMENT

The voltage transformer compartment can house a fixed type assembly VT or as an option a withdrawable type VT. For the withdrawable type VT, a positively driven shutter mechanism is installed inside the compartment.

DESIGN

Switchgear compartments

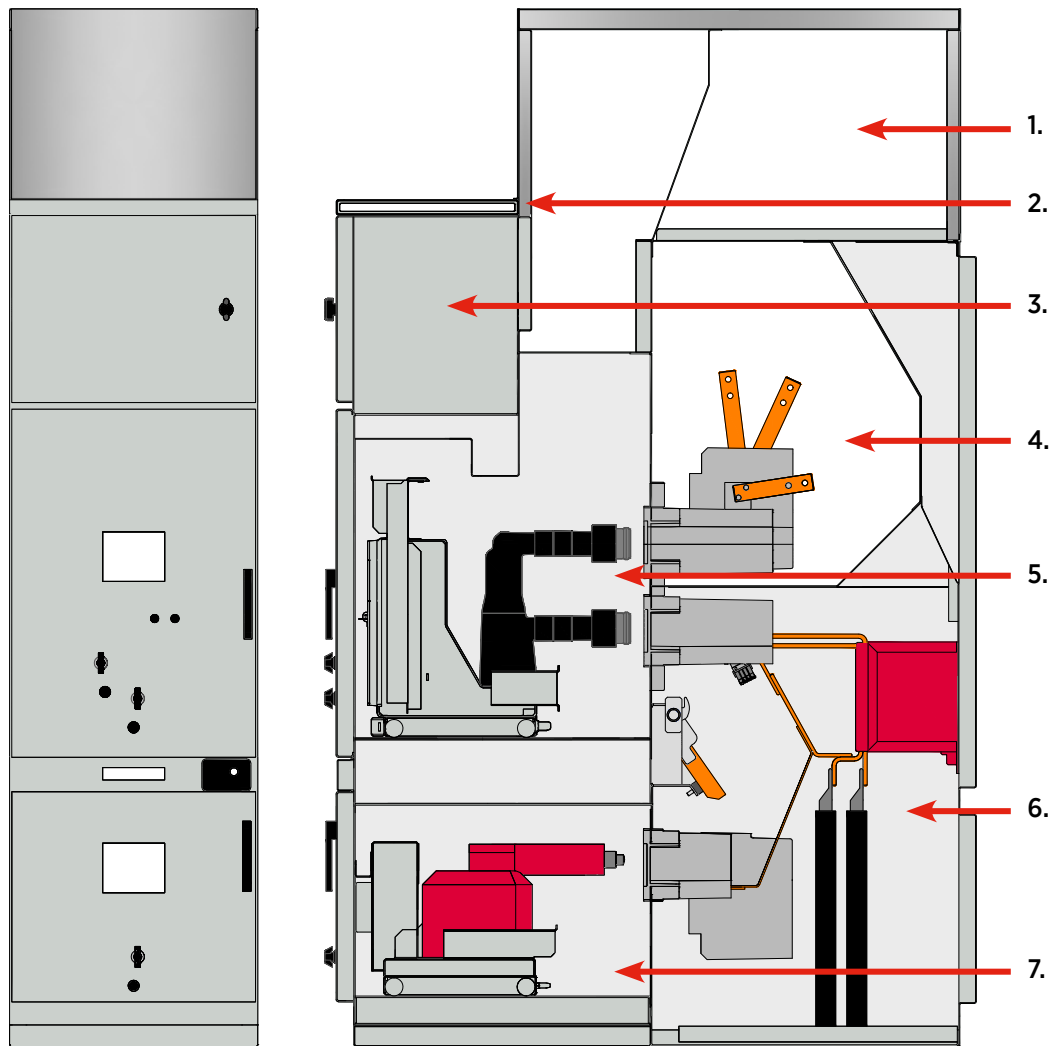

- 1. Gas exhaust compartment
- 2. Auxiliary circuit wiring duct
- 3. Instrument compartment
- 4. Busbar compartment

- 5. Circuit breaker compartment
- 6. Cable compartment
- 7. Voltage transformer compartment

EQUIPMENT AND COMPONENTS

Circuit breakers



VD4 VACUUM CIRCUIT BREAKER

The withdrawable VD4 circuit breaker uses vacuum as the insulating medium for long electrical life for the circuit breaker by also limiting the dielectric and thermal stresses on the installation.

The VD4's switching capacity is capable to handle sufficient conditions arising from switching of equipment and system components, in particular, short circuits. Type VD4 circuit breakers are suitable for auto-reclosing, are exceptionally reliable and have long life operation capabilities.

The operating mechanism of the VD4 circuit breaker is of mechanical type. The principle of stored energy mechanism with trip free contacts allows opening and closing operations independent of the operator's actions.



HD4 GAS CIRCUIT BREAKER

The withdrawable HD4 medium voltage circuit breaker uses sulphur hexafluoride gas (SF6) as the insulating medium for extinguishing the electric arc.

The breaking principle of HD4 circuit-breakers is based on the compression and self-blast techniques to obtain top performances at all service current values, with gradual arc extinction, eliminating the possibility of restriking or chopped currents. These mentioned characteristics provide the guarantee of extinguishing the electric arc.

The operating mechanism is the same as in the VD4 circuit breaker.

EQUIPMENT AND COMPONENTS

Instrument transformers and Testing truck

CURRENT TRANSFORMERS

MSGair can be equipped with insulated in resin current transformers used to power supply to measuring instruments and for feeding protection systems.

The transformers can have one or more cores with performance and precision classes fitting the installation requirements.

The current transformers installed comply with IEC 61869-1 Standards. Their dimensions are in accordance to the DIN 426300 Narrow Type Standard, in the Medium and Long Size versions.

The current transformers are equipped with a voltage capacitive divider which feeds the Voltage Presence Indication System.

VOLTAGE TRANSFORMERS

MSGair can be equipped with insulated in resin voltage transformers used to power supply to measuring instruments and for feeding protection systems. Two types of transformers can be installed: fixed type and withdrawable type (optional).

The voltage transformers installed comply with IEC 61869-2 Standards. Fixed type transformers have their dimensions in accordance to the DIN 426300 Narrow Type Standard. Withdrawable type transformers are fitted with medium voltage protection fuses. Fuse replacement can be carried out with the switchgear in service.

POWER CABLE TESTING TRUCK

A power cables test truck is also available in order to allow insulation tests to be carried out on the power cables without accessing the feeder unit or disconnecting the cables from the switchboard.

During the racking-in phase, the truck lifts the bottom shutter only and, by means of the connectors it is fitted with, allows connection of the test apparatus by means of a special insulating rod. The truck can be used on incoming and outgoing units.

INTERLOCKS

Mechanical and Electromechanical

A high degree of operator safety is of utmost importance in the design of switchgear. The MSGair is fitted with necessary interlocks in order to prevent mal-operations which might endanger the operating and maintenance personnel of the switchgear.

The MSGair has been designed with numerous mechanical safety interlocks while this can also be complemented with supplementary electromechanical interlocks.

MECHANICAL INTERLOCKS

The following locking devices are provided in the circuit breaker compartment in order to prevent the mal-operations:

- The circuit breaker cannot be inserted unless the low voltage socket board is connected.
- The circuit breaker cannot be closed in the intermediate position
- The circuit breaker cannot be racked out in the closed position.
- The circuit breaker cannot be racked in with the circuit breaker compartment door open.
- The circuit breaker cannot be racked in from the isolated position with the circuit breaker contacts in the closed position.
- The circuit breaker compartment door cannot be opened when the circuit breaker is in the intermediate position.
- A key lock is provided on the racking in shutter.

In the case that the MSGair is fitted with a withdrawable type VT, the following locking devices are provided in the Voltage transformer chamber compartment in order to prevent mal-operations:

- The voltage transformer cannot be racked in with the voltage chamber compartment door open.
- The voltage chamber compartment door cannot be opened when the voltage transformer is in the intermediate position.
- A key lock is provided on the racking in shutter.

The MSGair is also equipped with the utmost safety measures when it comes to cable earthing. The following interlocks are provided:

- The earthing switch cannot be closed when the circuit breaker is in the connected or intermediate position.
- The circuit breaker cannot be racked in when the earthing switch is closed.
- Key locks are provided in order to lock the earthing switch and the open position as well as in the closed position.

ELECTROMECHANICAL INTERLOCKS

The MSGair can also be equipped with electromechanical interlocks whereby the following devices can be locked:

- The earthing switch operation can be blocked unless the electromechanical lock is energized.
- The racking shutter of the circuit breaker can be locked unless the electromechanical lock is energized.

TYPICAL UNITS THE MSG^{AI} RANGE

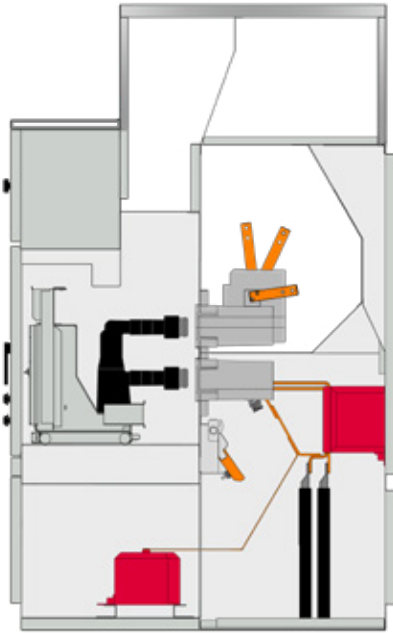

IF - with fixed VT

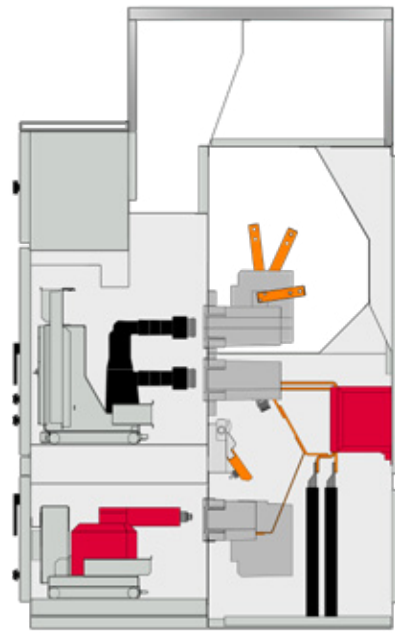

IF - with withdrawable VT
(optional)

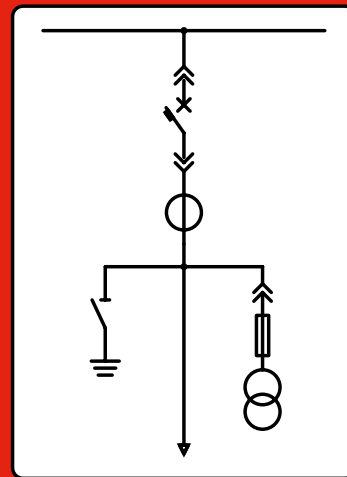
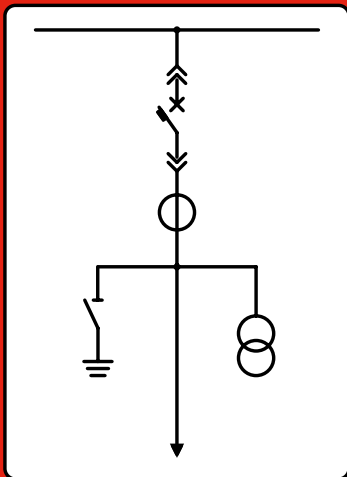

TYPICAL UNITS THE MSG^{AI} RANGE

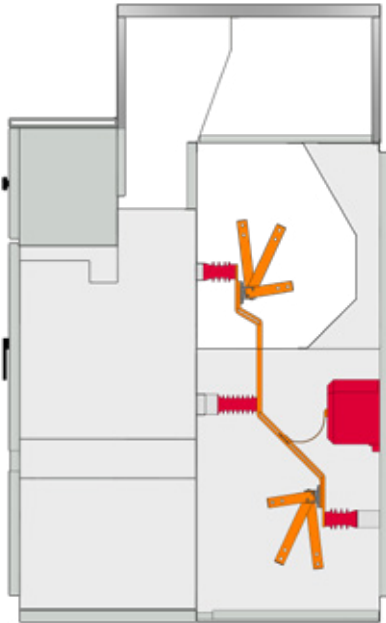

R - with fixed VT

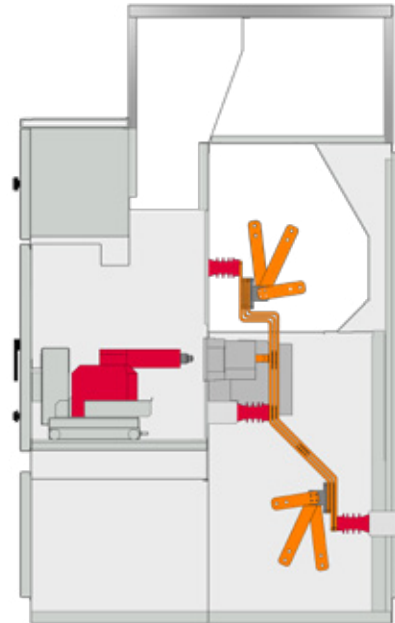

R - with withdrawable
VT (optional)

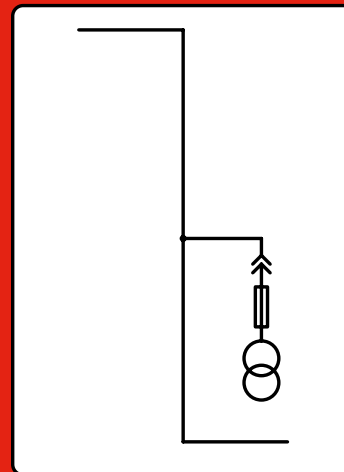
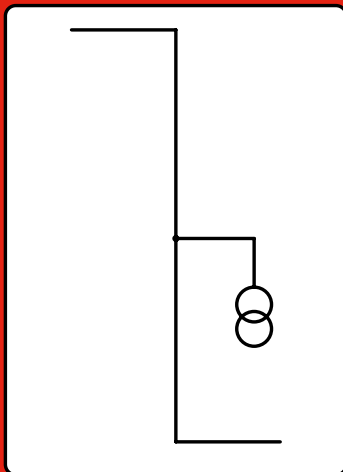

TYPICAL UNITS THE MSG^{AI} RANGE

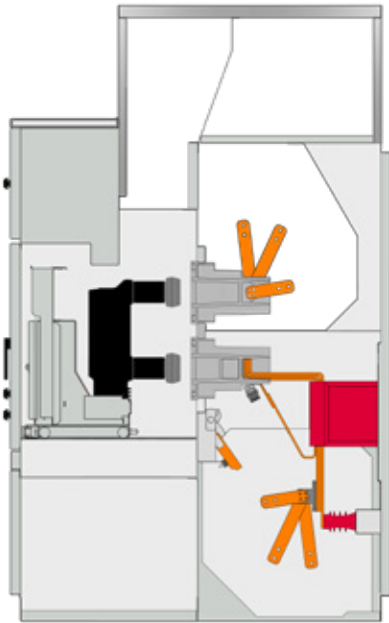

BT

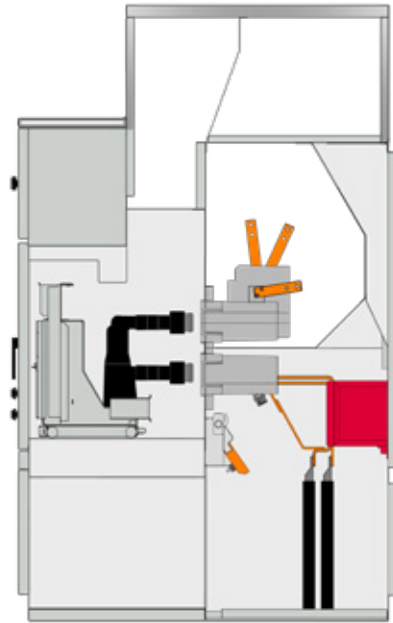

OF

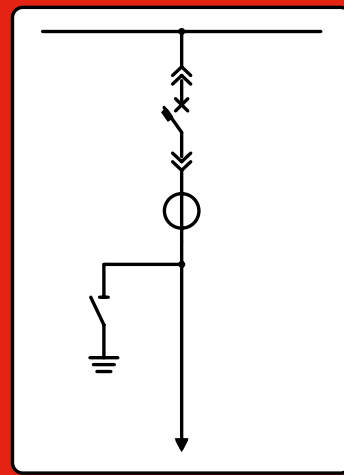
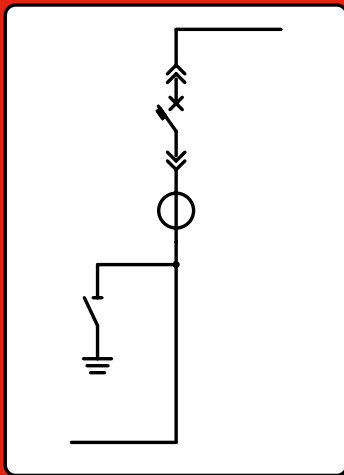

TYPICAL UNITS THE MSG^{AI} RANGE

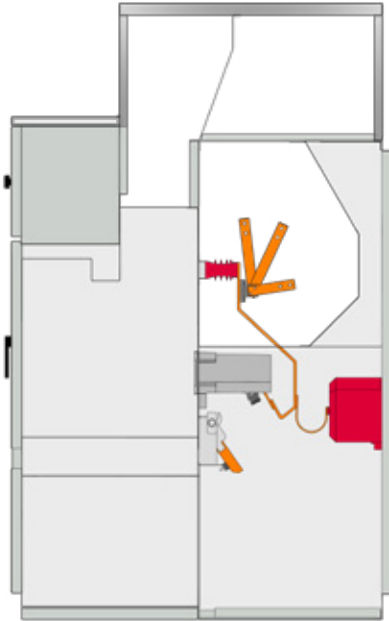

M - with fixed VT

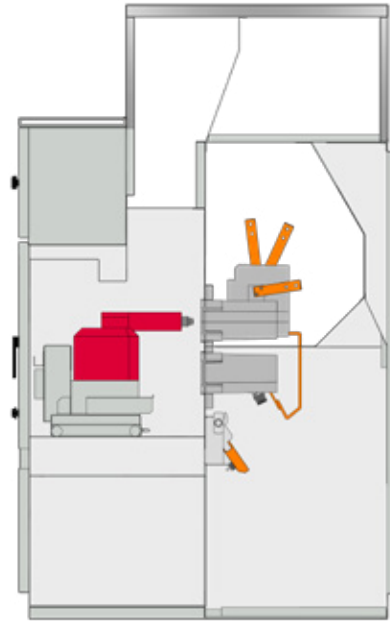

M - with withdrawable VT
(optional)

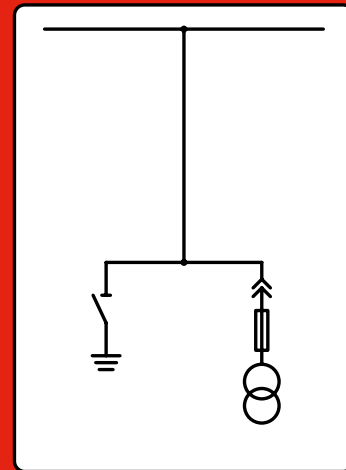
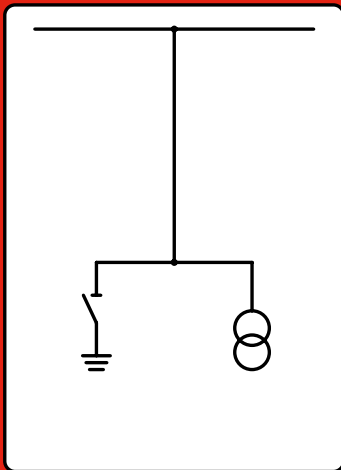

TYPICAL UNITS

Type of unit, ratings and dimensions

Height of standard panel (mm)	2050						
Height with gas exhaust duct (mm)	2510						
Depth (mm)	1550						
Width (mm)	600			750			
Rated current of circuit breaker (A)	-	630	1250	-	1250	1600	2000
IF - Incoming Feeder		•	•		•	•	•
BT - Bus Tie		•	•		•	•	•
R - Riser	•	•	•	•	•	•	•
OF - Outgoing Feeder		•	•		•	•	•
M - Measurement	•						



HEAD OFFICE & FACTORY

BLB033, Bulebel Industrial Estate, Zejtun ZTN 3000
P.O. Box 20, Paola PLA 1001, Malta.
T. (+356) 21693750 - F. (+356) 21693754 - E. info@medelec.com.mt

TRIPOLI OFFICE

Madaris El Funun W Assanaqa
Building 82, Flat 9, 24th December Street, P.O. Box 82118, Tripoli, Libya.
T. & F. (+218) 21 4444050

www.medelec-switchgear.com